

INDUSTRIAL DOORS





Contents

Intro	5
TLP Rib	7
TLP Macrorib	9
Glazing Options	11
Wicket door	13
Side door	15
TLP Full View	17
TLP Full View Thermo	19
TLT	21
TLP Ultra Thermo 80	22
TLP - FV Ultra Thermo 80	23
Tracks	24
Match the Style	29
Handles and locks	30
Safety edge options	30
Operation	31
ISFD Side Sliding Framed Doors	32
ISSD Side Sliding Sectional Door	33
ISH2 Industrial Side Hinged Doors	34
Panel options	35
Tailored engineering	35



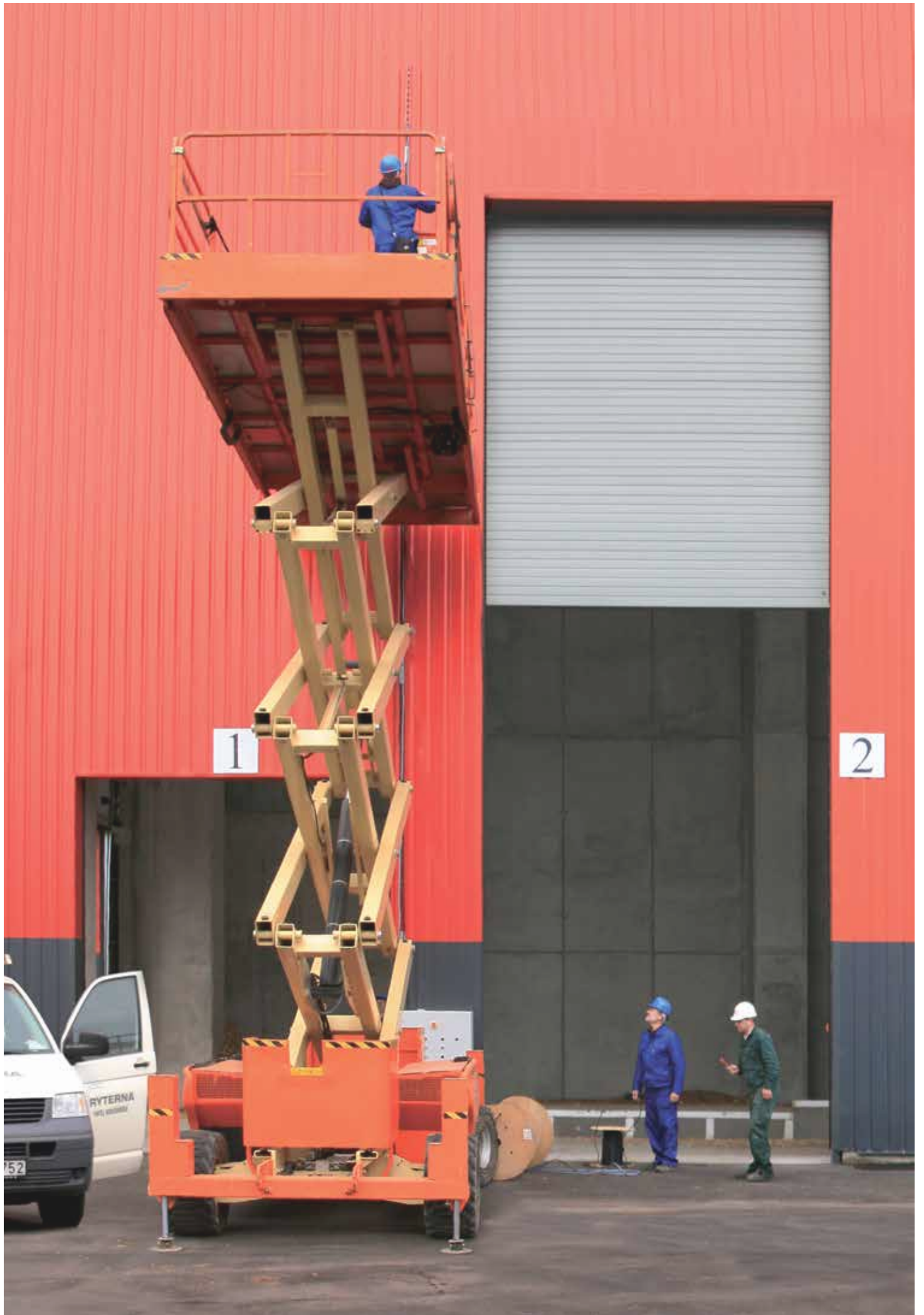

Industrial doors – built to serve



Ryterna manufacture several types of industrial doors. Each door we build exactly for its purpose. Of course durability and performance are key factors. But we care about door aesthetics as well. It is important how your industrial surrounding looks like.

We specialize in designing and manufacturing large size special doors of various types. Each case is unique. Therefore we are ready to help you to choose right type of the door to get the best performance.

Having specialized in sectional door manufacturing for more than twenty years we have developed a wide product range. From solid design, materials, insulation and hardware — to fast delivery and reliable service.

Numerous sectional door manufacturing facilities equipped with continuous production lines, supply sectional door products all over Europe. For further information on any of our product range, please, contact your nearest RYTERNA distribution office where a member of our staff will be happy to assist you with any enquiry.

Variety. Vast range of panel designs. RYTERNA offers a standard panel range as well as many exclusive and unique designs to fit the most demanding requirements.

Tailored. Each RYTERNA door is tailor made using the exact dimensions of your opening. This ensures the door you choose is manufactured according your specifications at no extra cost.

Quality & Safety. The company works in accordance to EN ISO 9001:2000 quality standards. Products are tested to meet CE requirements in accordance to the standard EN 13241 - 1, include anti-pinching panels and hardware, spring brake safety devices and other equipment to warrant safe operation. RYTERNA quality system, along with years of experience, helps us making a top-line sectional door.

Insulation. RYTERNA sectional door panels are made of double skin zinc coated, primed and painted steel tin filled with 40 mm PU layer. Tight weather-sealing all around the door provides efficient thermal insulation.

Delivery. All doors are delivered by Ryterna fleet. Firm and easy to handle packing significantly reduces risk of damage up to fitting moment.



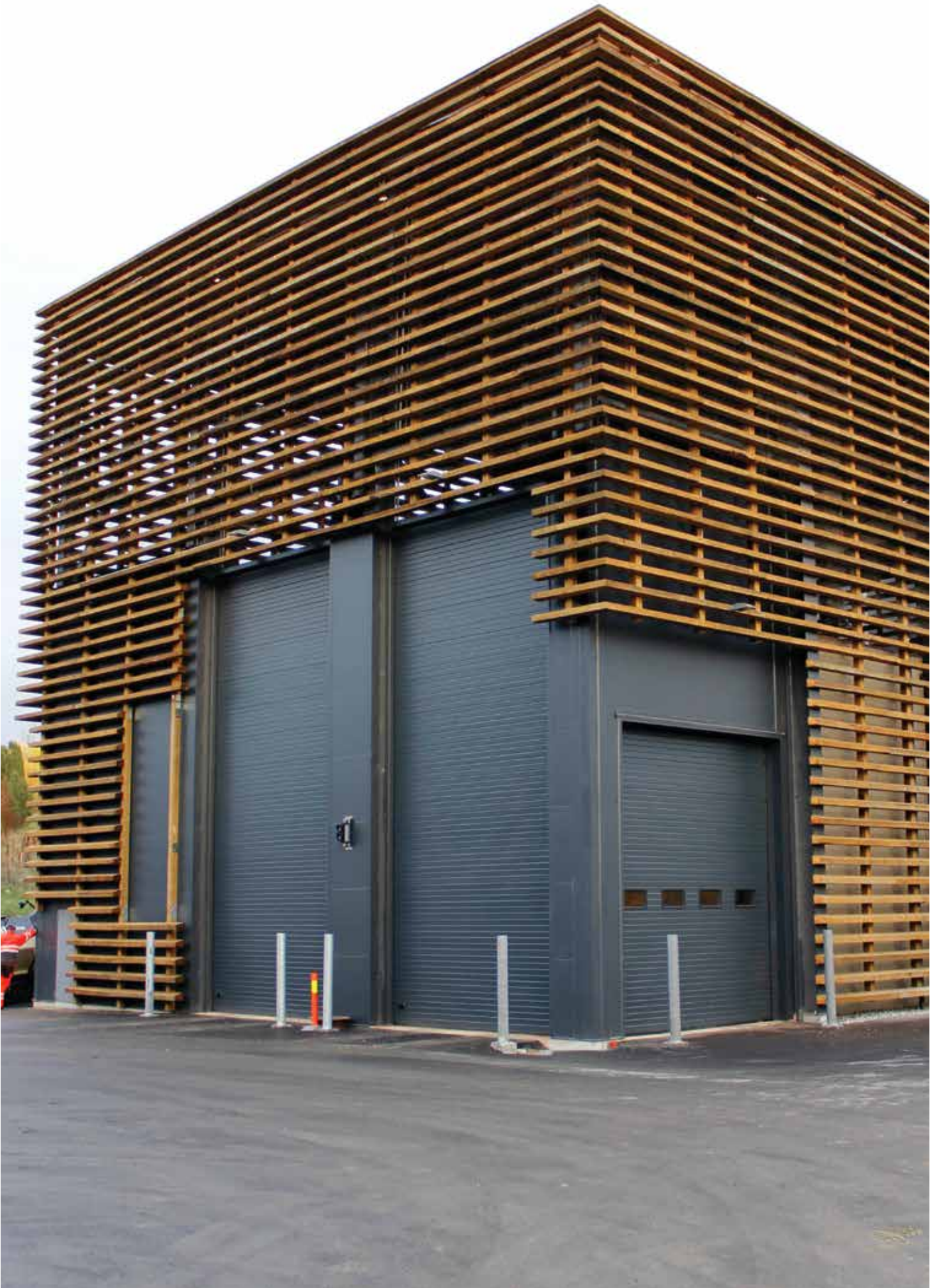

TLP Rib

Rib panels surface have standard 'Stucco' pattern.

Double-Skinned 40 mm thick PU insulated panels provides good thermal insulation. Standard panel heights — 500 and 610 mm. Sections of this type can be used in the door up to 50 square metres.

10cm high horizontal ribs the door lightweight look and extra sturdiness at the same time.

TLP RIB doors are available in 12 standard colors. Any other RAL palette colour available.

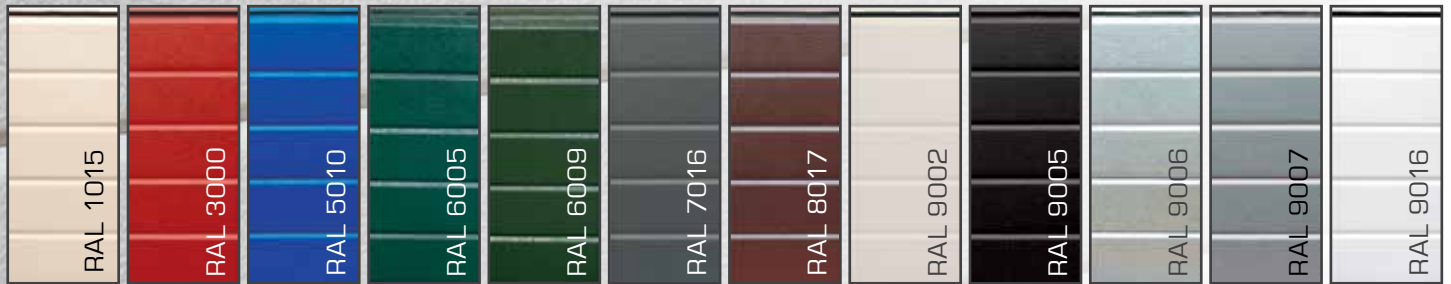



TLP Macrorib

Macrorib panels surface have standard 'Stucco' pattern.

The surface of Macrorib door is stucco embossed and formed in soft waves, every 10 mm. Nice looking modern style door, suitable for commercial architecture.

Standard panel heights are 500 and 610 mm.

Macrorib doors comes in standard RAL 9007, RAL 7016 and RAL 9016 or painted any RAL colour.





Rectangular window
 Black plastic frame
 Double acrylic glazing.
 Dimensions — 640x336mm



Oval window
 Black plastic frame
 Double acrylic glazing
 Dimensions — 670x345mm



Rectangular window
 Black plastic frame
 Double acrylic glazing
 Dimensions — 610x200mm



Decorative round window
 Stainless steel frame
 Safety glass
 Diameter: 315mm; 235mm; 155mm



Decorative round windows
 Stainless steel frame painted RAL colours
 Safety glass
 Diameters: 315mm; 235mm; 155mm



Decorative square windows
 Stainless steel frame
 Double safety glass
 Dimensions: 315x315mm; 235x235mm; 155x155mm



Decorative rectangular window
 Stainless steel frame
 Double safety glass
 Dimensions — 805x155mm

Glazing Options

3 types of windows – round, oval and rectangular are available. Double acrylic glazing with plastic frame – as a standard. For more stylish effect – stainless steel windows with one layer, or double safety glass – upon request. Stainless steel frames painted RAL colours are available.





Wicket door

When additional entry is required and there is no space for the side door, — the wicket door could be an option. As a standard, wicket doors are supplied with a door closer, lock and handle. You can choose either standard or a version with a low threshold which is more convenient to pass through.

Standard opening sizes 800mm wide and 1900-2300mm high depending on door layout. Max wicket door opening width 1200mm (consult manufacturer about possibility for wide doors).

Pass door in TLP door is factory pre-assembled with lock and sliding door closer.

Options with magnetic or mechanical pass door closure switch, various anti-panic lock options are factory pre-installed on request.

Pass doors can be made in double skinned sandwich panels or full vision aluminium panels. Also in various combinations of them.

For additional security – 3 point lock is optional.



Standard threshold



Low threshold

Standard handle colour – silver
Black and white – on request



Anti-panic lock



Anti-panic lock with opening bar





SIDE DOOR FITTING AND OPENING OPTION

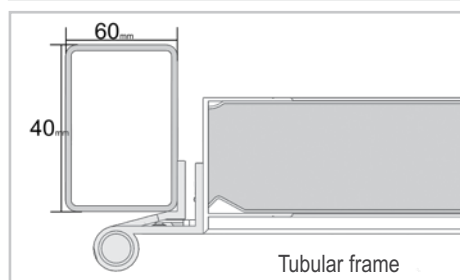
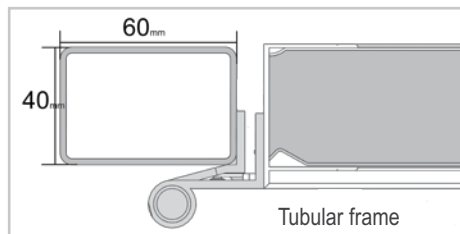
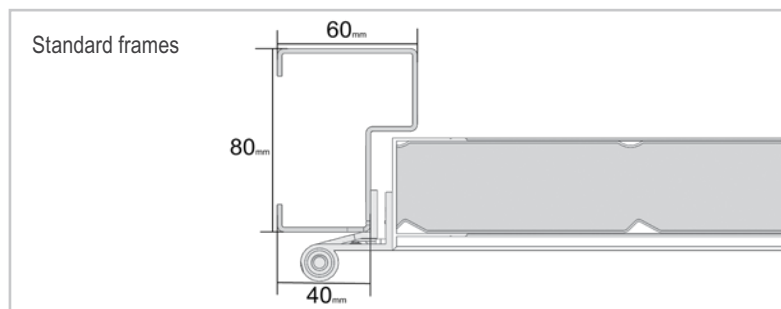
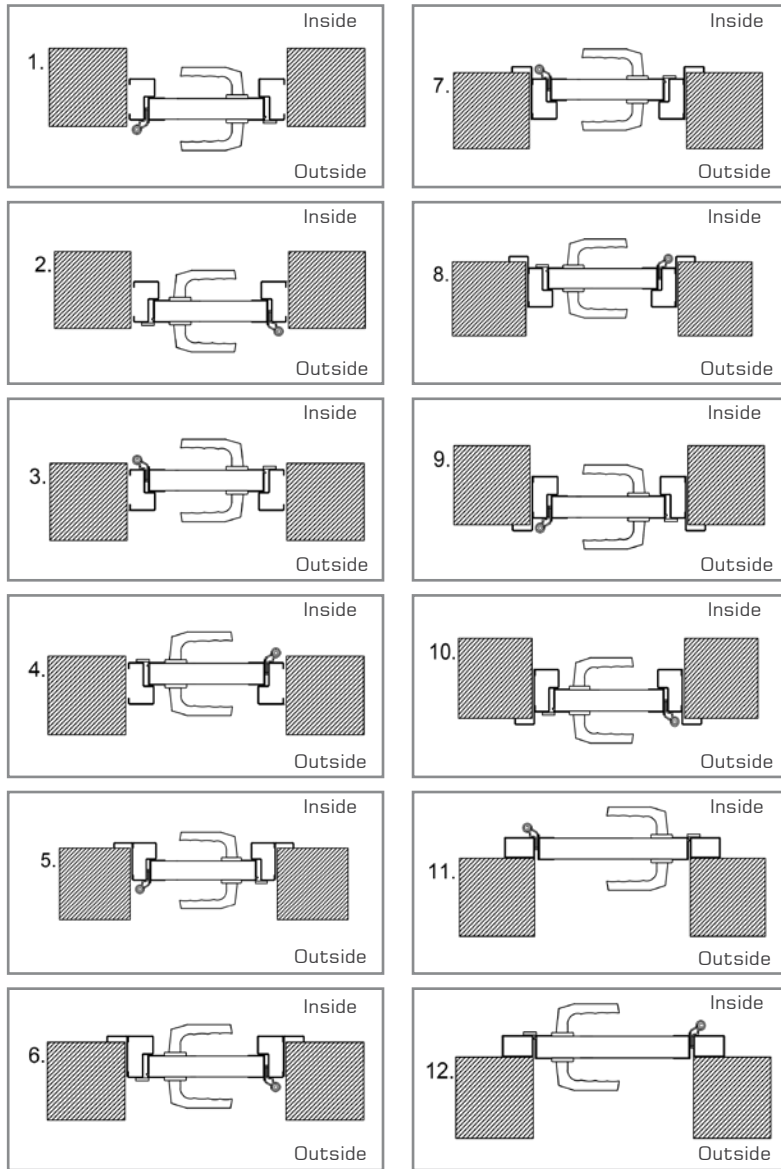

3 point lock



Side door

Side doors are made according to the style and parameters of the panels, including aluminium frames and glazing.

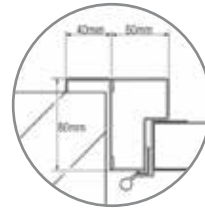

Frame dimensions

Standard handle colour – silver
Black and white – on request

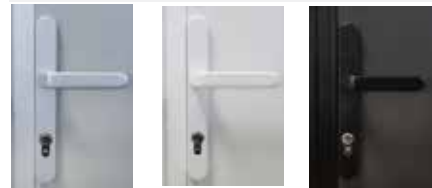

Anti-panic lock / Anti-panic lock with opening bar



Door stays



Frame mouldings



Side doors threshold

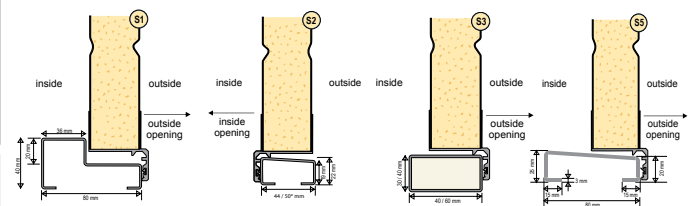



TLP Full View

FV - standard

TL-FV door panels - anodized aluminium frames glazed with double acrylic glass comes as a standard, Aluminium profiles can be painted any colour including metallic finish.

Optionally You can choose: acrylic, Anti-Scratch, tinted, matt, polycarbonate or safety glass.

White, sandwich type bottom panel is standard for TL-Full View doors.

Glazed or 'sandwich' filled bottom panel is optional.



Natural safety glass

Standard clear acrylic

Clear anti-scratch

Tinted

Matt

Polycarbonate





TLP Full View Thermo



Aluminium profiles with thermal break significantly upgrade the insulation value of a panoramic sectional door panels. FV Thermo doors are produced up to 7 meters wide, 6 meters high, with standard double panes of acrylic glazing or double Anti-Scratch glazing. Concerning possible measurements of doors, glazed with double Safety Glass — consult the factory.

Optional tinted glazing provides higher thermal value.



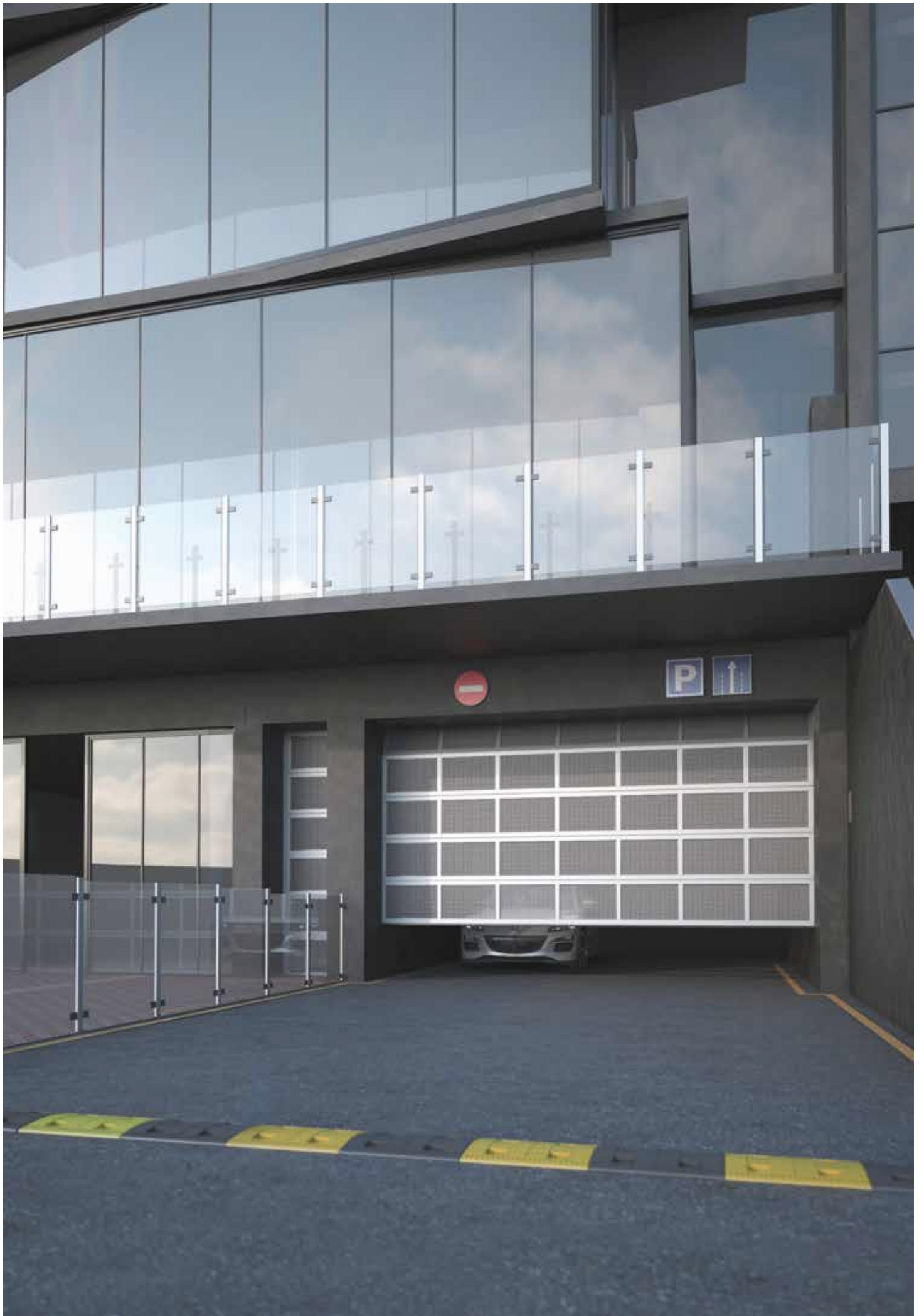

TLT



TLT sectional doors are designed for premises that require intensive ventilation, such as underground garages and car parks. Alu-frame with perforated, galvanized and coated steel sheets provides required air flow.

On demand we offer two types of ventilation grids, with two different air flow spaces – 5 mm and 10 mm wide.

The number of the perforated panels, both in the door and side doors, could vary depending on the air flow requirements.

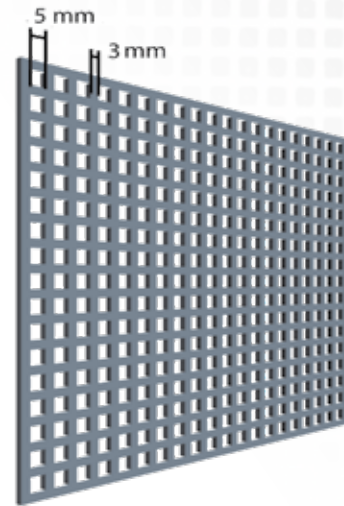
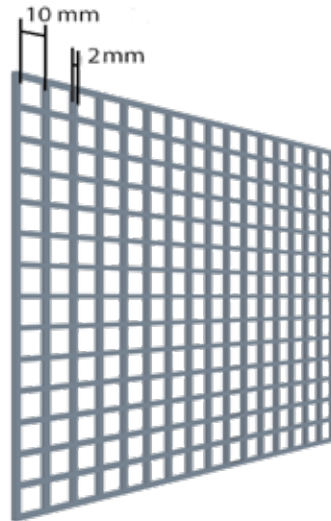

TLP Ultra Thermo 80

Ultra Thermo Industrial doors are designed and manufactured to save thermal energy in heated or refrigerated premises. Thermo brake between inner and outer steel surfaces and 80 mm thick, high density polyurethane insulation, provides excellent thermal value of the door up to $0.5 \text{ W/m}^2 \text{ K}$.

Triple pane thermal insulation protects from the heat loss similarly to unglazed walls.

Pass doors are not recommended to ensure higher thermal protection.



Triple acrylic glazing



TLP FV - Ultra Thermo 80



80 mm thick aluminium profiles with 30 mm PU foam thermal break

Made to measure up to:

- 6000 mm wide and
- 5000 mm high
- U value = 2.0W/m²K

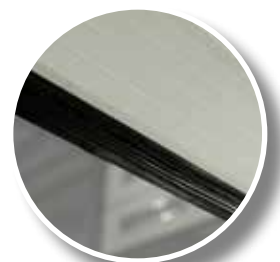
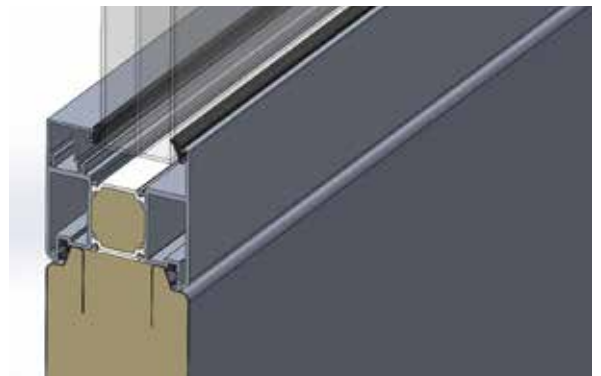

Tracks

No matter what door type You have chosen, selected track applications will exactly match Your door.

Standard, low headroom or inclined are available



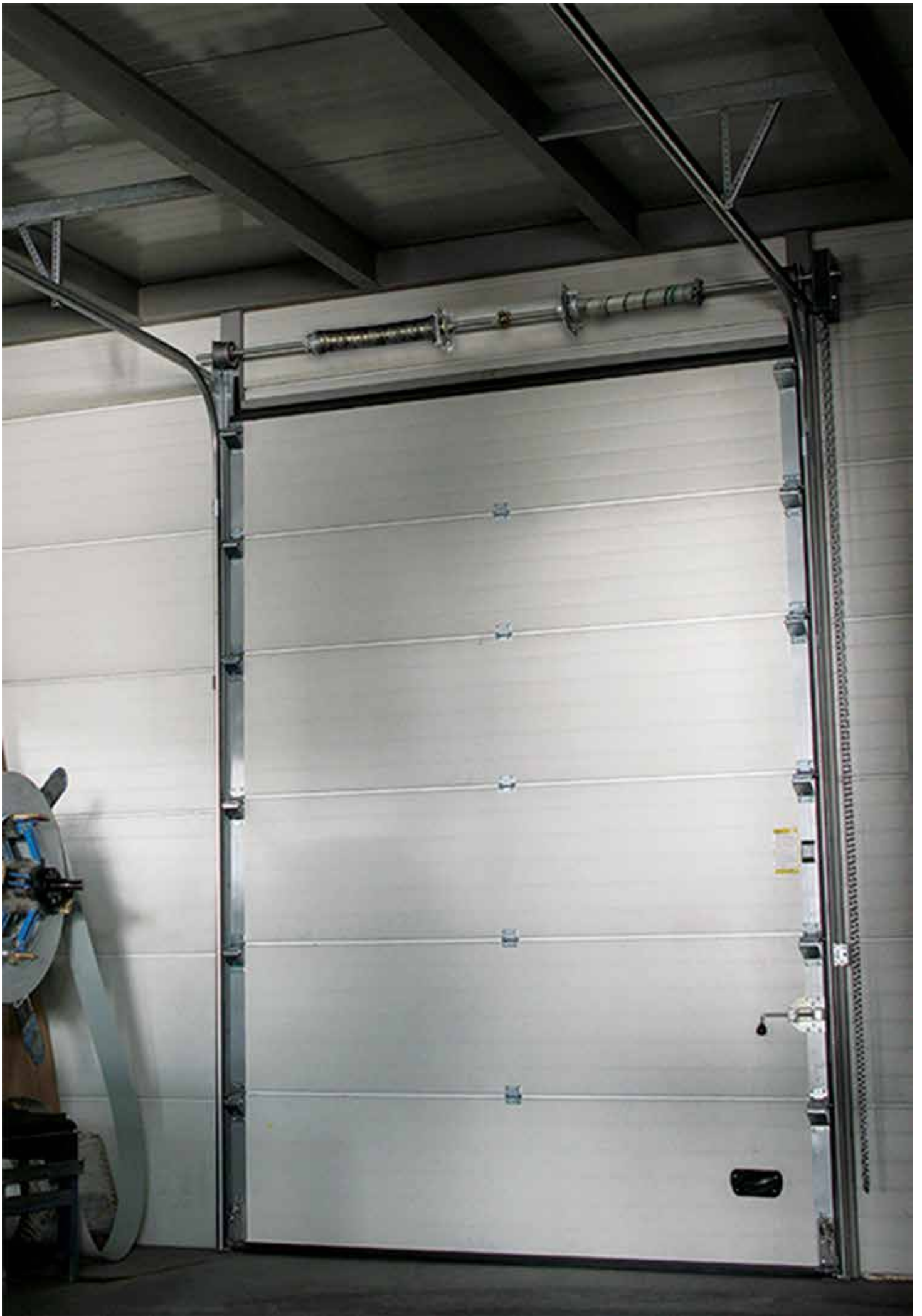

STD

standard

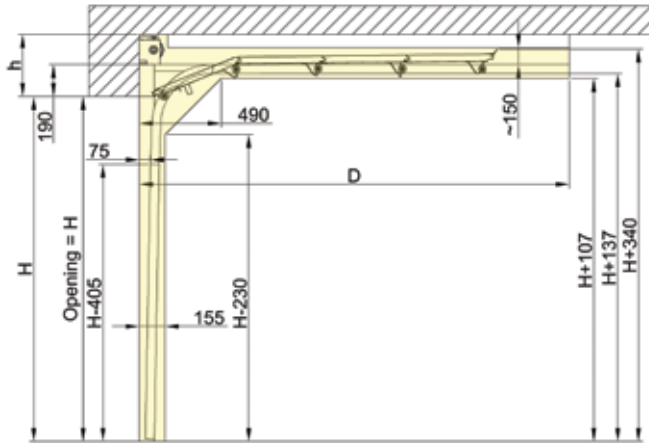

STD-RM

standard, spring rear mounted

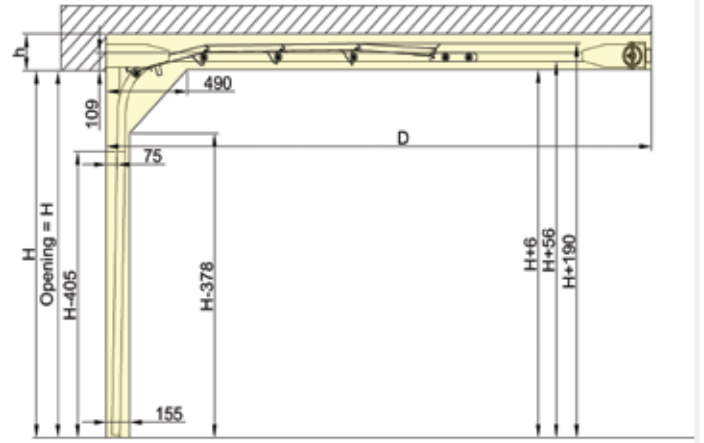

LHR-FM

low headroom, spring front mounted

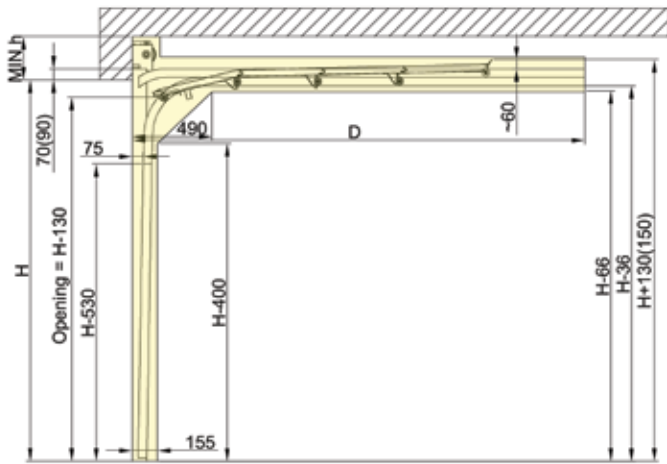

LHR-RM

low headroom, spring rear mounted

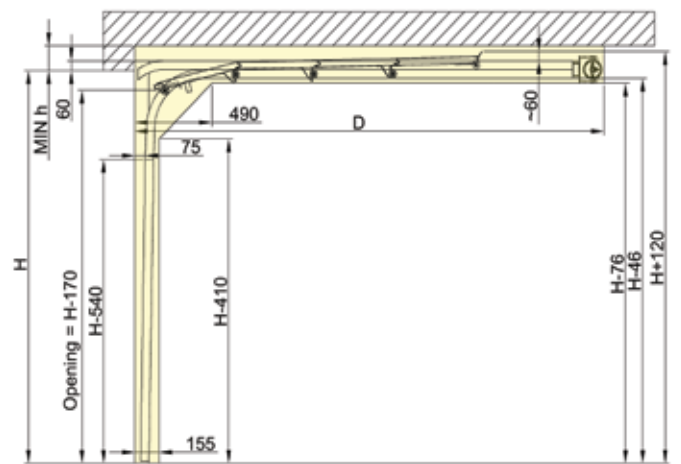

HL

high lift

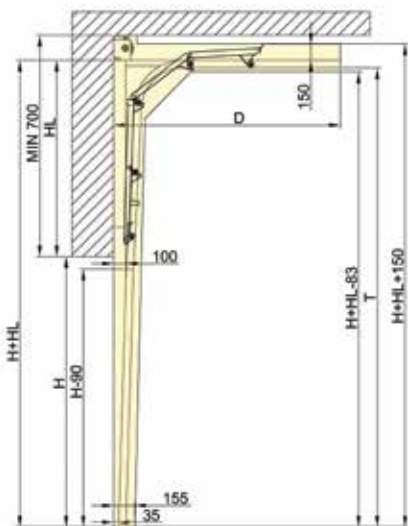

HL MM

high lift with console

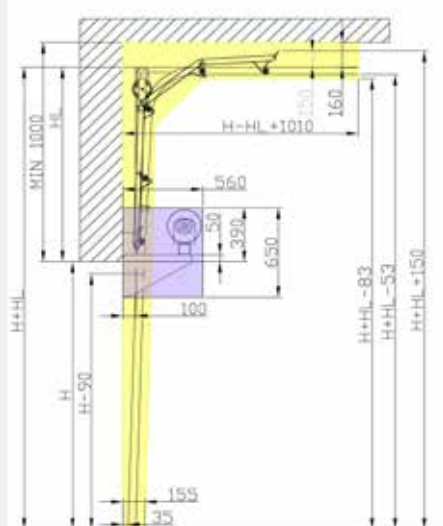

HL MM2

high lift with console

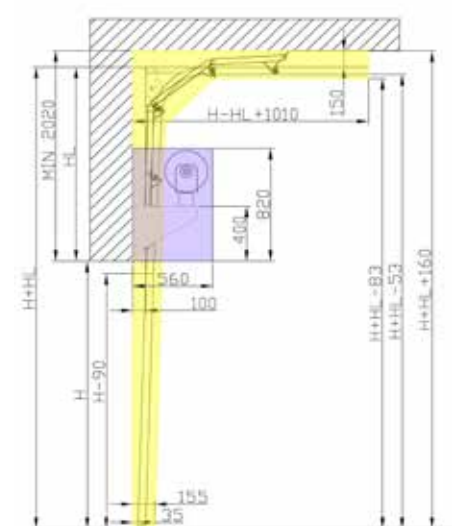





Match the Style

Going in tune with the surrounding architecture we can offer the whole complex of visual elements that will fit the rest of the style. Panel surface, colour, painted elements or appliqués will match the style of whole ensemble.



Handles and locks

Handle (outside)



Handle (inside)



Manual lock



Safety edge options

Pneumo

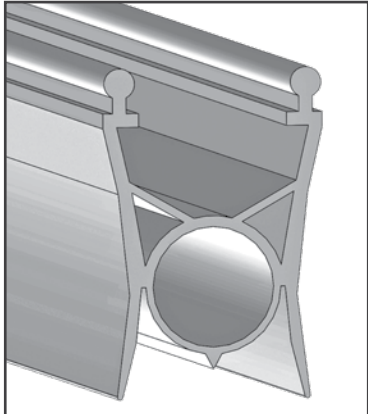

Opto

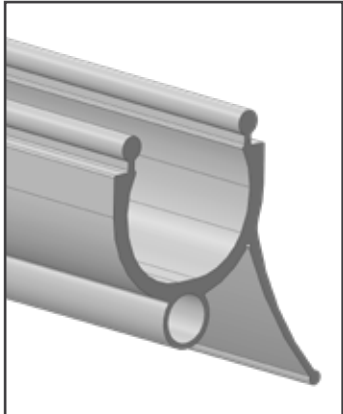

Operation

Chain hoist

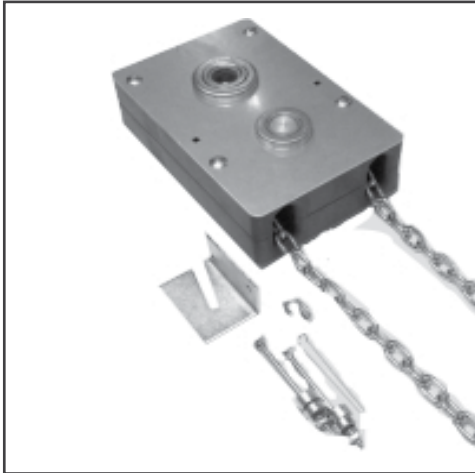

Chain tensioner



Dickert controls 1-phase



Cable tensioning kit



Operator kit



Cable break safety device - Burglar Proof System



Cable break safety device



ISFD

Side Sliding Framed Doors



Heavy-duty guide rails and carriages



Side lock or floor lock options



Embedded handle



Solid bottom guide rollers

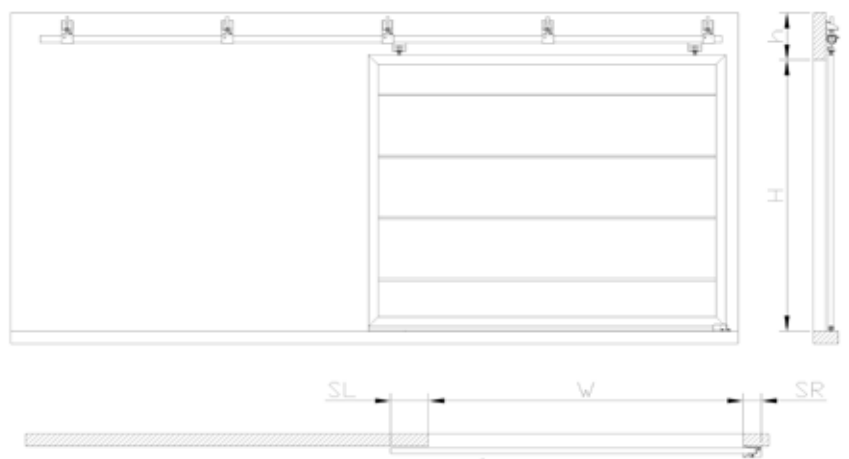

WxH (max), mm	Max weight, kg	h, mm	SL, mm	SR, mm
3500x2500	170	200	150	140
4000x4000	300	280	300	140
>4000x4000	600	410	300	190
	1200	510	300	190

ISSD Side Sectional Sliding Door



Vertical panel layout gives possibility to build door up to 30 metres wide and up to 15 metres high.

Heavy duty guiding rail and roller system ensures smooth and reliable operation.

Door is moving sideways – space under the ceiling is free for cranes and industrial equipment.

Custom made bended guiding rail corresponds perimeter walls so the door occupies as little space as possible.

Door is compatible with most electric drives. Pneumatic safety edges and infrared beam protective devices will make door operation safe.

Wicket door gives possibility to save energy costs.

Narrow bottom supporting groove requires very low service and provides smooth passage even for small trolleys and forklifts.

High wind load resistance allows to install doors in open and windy places.

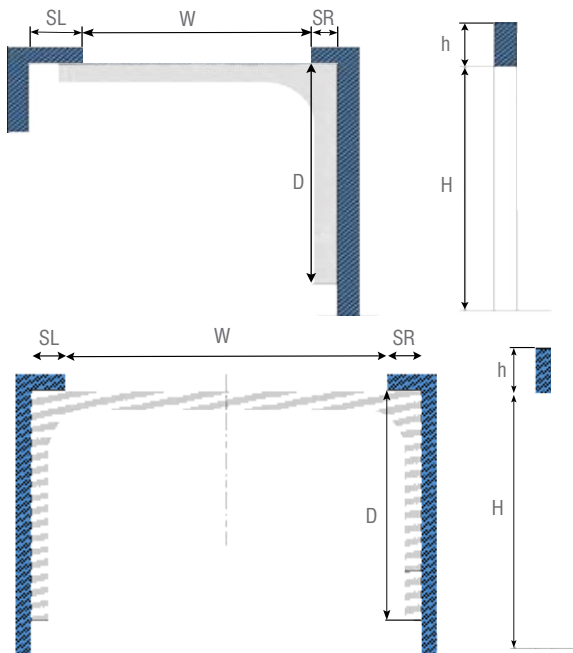

		Manual				
WxH (max), mm		h, mm	SL, mm	SR, mm	D, mm	
Single leaf	10000x8000	400	750	75	W	
Double leaf	20000x8000	400	750	750	W/2	

		Automatic				
WxH (max), mm		h, mm	SL, mm	SR, mm	D, mm	
Single leaf	10000x8000	1100	1750	300	W-1000	
Double leaf	20000x8000	1100	1750	1750	W/2-1000	

ISH2

Industrial Side Hinged Doors



Industrial Side Hinged Doors could be perfect choice where conventional industrial doors can't be installed. Main application areas: agriculture, workshops, storage spaces, big garages. Insulated and reinforced leaves, steel frame, heavy duty hinges ensure high durability and perfect performance. Standard sizes up to 5 x 5 metres. For bigger sizes consult manufacturer.



Standard options:

- Inside locking
- Assembly on site frame.
- Horizontal panel layout
- Rib & macrorib panels, standard TLP colours
- Anodized aluminum profiles

Additional options:

- Outside locking
- Wicket door
- Windows
- FV, TLT panels
- Door stays

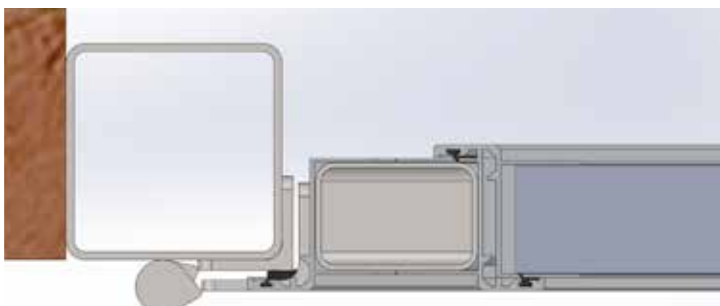

Panel options

Despite - standard Rib and Macrorib panels we can offer full range of panels that will - make You door look exceptional and match the style.



Slick

Flush

Midrib

Microrib

Toprib

Cassette

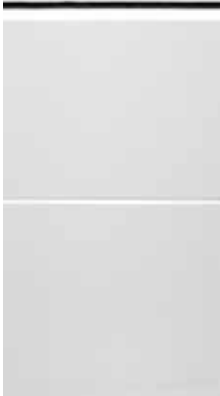
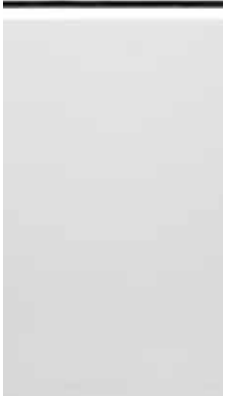

Tailored engineering

Industrial size swing door



Sloping floor case





Extra height direct drive operation





Boat parking door



Side hinged - 10 meters high



Solutions up to 15 meters wide



Conveyor closing options



Conveyor closing case

